



# INTEGRA™ IT-8000

Niagara Framework Network Controller / Web Server

## DESCRIPTION

Part of the INTEGRA™ family, the IT-8000 is an embedded Internet of Things (IoT), BTL-listed BACnet® Building Controller (B-BC) that connects to Cylon's BACnet field controllers. The IT-8000 is also capable of connection to and network management of a variety of diverse devices and subsystems using various protocols including, but not limited to, Modbus™ and LonWorks™.

When connected to an Ethernet or wireless LAN, the IT-8000 uses Internet connectivity and web-serving capability to provide integrated control, supervision, network management, scheduling, data logging, alarming, and rich graphical displays through a standard Web browser.

## APPLICATION

With simple configuration, tool-less installation, enhanced integration and high-powered performance, the INTEGRA™ IT-8000 controller provides ultimate flexibility in connecting and controlling buildings worldwide.

- Remote connectivity allows control, monitoring, and management of field controllers
- Scalable hardware and software make it suitable for installation in small building to large campus applications
- The INTEGRA-Supervisor software can connect multiple IT-8000 controllers and their data to provide aggregated information, such as; archiving, master scheduling, real-time data, history, and alarms, to create a single, unified application.

The licensing model for the INTEGRA™ IT-8000 controller is scalable and features standard drivers along with optional I/O and field bus expansion modules for ultimate flexibility and expandability. The INTEGRA™ IT-8000 controller operates with Niagara Framework® for optimum performance.

### TI AM3352: 1000MHz ARM® Cortex™-A8

1GB DDR3 SDRAM and 4GB flash storage using a removable micro-SD card

### Wi-Fi Client or Wireless Access Point

- IEEE802.11n HT20 @ 2.4GHz
- IEEE802.11n IEEE802.11n HT20/HT40 @ 5GHz
- Configurable radio (Off, WAP, or Client) WPAPSK / WPA2PSK

### Ports and Connections

- Two 10/100MB Ethernet ports
- Two on-board isolated RS-485 ports for connecting BACnet MS/TP and Modbus RTU devices
- One USB Type A Connector supports stations back-up and restore

### Secure boot, Battery-less, Real time clock

### Expansion I/O Modules

- IT8-EIO-16 (8 UI, 4 DO-R, 4 AO)
- IT8-EIO-34 (16UI, 10 DO-R, 8AO)

### Expandable Option Modules

- IT8-NPB-LON – LonWorks LON FTT10A module
- IT8-NPB-2X-485 – Dual port RS-485 module
- IT8-NPB-232 – Single port RS-232 module

### INTEGRA-ProPack Service

Cylon Service for quick database import that automatically creates BACnet network, devices and points without the need for discovery

## INTEGRA-ProPack | IMPORT OF NETWORK DATA FROM CXpro<sup>HD</sup> TO AUTOMATICALLY CREATE BACNET NETWORK, DEVICES AND POINTS

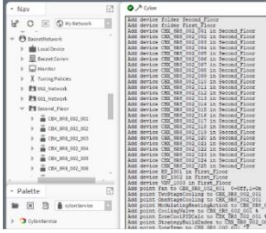

The **IT-8000** uses Cylon's **INTEGRA-ProPack** service to reduce deployment time when connecting to the Cylon's BACnet field controllers. The **INTEGRA-ProPack** is a database import tool that automatically creates the BACnet network, devices and points in the IT-8000. This service helps to reduce programming time when deploying a new project to the IT-8000. The **INTEGRA-ProPack** quickly and easily exports network data from **CXpro<sup>HD</sup>** and imports it into the IT-8000, without the need to discover controllers and points.

### SPECIFICATIONS

#### CONNECTION

**Note:** Use Copper or Copper Clad Aluminum 70 °C conductors only.

Terminals	PCB mounted plug terminal connections
Conductor Area	Max: AWG 12 (3.31 mm <sup>2</sup> ) Min: AWG 22 (0.355 mm <sup>2</sup> )

#### MAXIMUM EXPANSION MODULES SUPPORTED

IT8-NPB-LON	4
IT8-NPB-232	4
IT8-NPB-2X-485	2

#### I/O CONFIGURATION

IT-8000 Maximum Combinations

EXPANSION 1	EXPANSION 2	EXPANSION 3	EXPANSION 4
RS-232 or LON	RS-232 or LON	RS-232 or LON	RS-232 or LON
(2) RS-485	RS-232 or LON	RS-232 or LON	RS-232 or LON
(2) RS-485	(2) RS-485	RS-232 or LON	
(2) RS-485	(2) RS-485		



#### Expansion I/O Units

<b>IT8-EIO-16</b>	<ul style="list-style-type: none"> <li>8 Universal inputs: Type 3 (10k) thermistors, 0 ... 100K ohm, 0 ... 10 V DC, 0 ... 20 mA with external resistor</li> <li>4 Relay outputs (Form A contacts, 24 V AC @ .5 amp rated)</li> <li>4 Analog outputs (0 ... 10 V DC)</li> <li>Powered from IT8-EIO-34</li> </ul>
<b>IT8-EIO-34</b>	<ul style="list-style-type: none"> <li>16 Universal inputs: Type 3 (10k) thermistors, 0 ... 100K ohm, 0 ... 10 V DC, 0 ... 20 mA with external resistor</li> <li>10 Relay outputs (Form A contacts, 24VAC @ .5 amp rated)</li> <li>8 Analog outputs (0 ... 10 V DC)</li> <li>Powered from a 24 V AC/DC source</li> <li>Can power up to 4 IT8-EIO-16 modules</li> </ul>
<b>Maximum Expansion</b>	<ul style="list-style-type: none"> <li>16 x IT8-EIO-16 or</li> <li>8 x IT8-EIO-34</li> </ul>

#### COMMON EXPANSION I/O CONFIGURATIONS

2 Panels

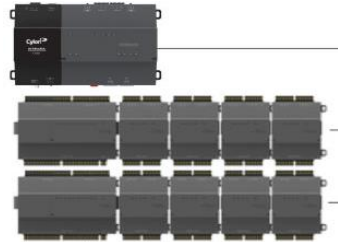

4 Panels

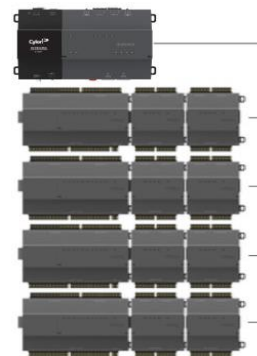

8 Panels

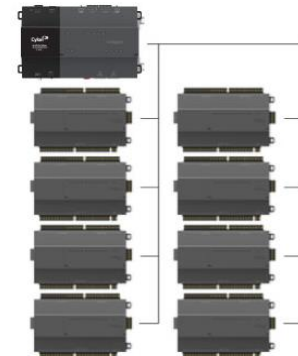

#### ENVIRONMENT

**Note:** This equipment is intended for field installation within an enclosure.

Operating Temperature	-4 °F ... 140 °F [-20 °C ... 60 °C]
Storage Temperature	-40 °F ... 185 °F [-40 °C ... 85 °C]
Ambient Humidity	5% ... 95% RH non-condensing
Shipping & Vibration	ASTM D4169, Assurance Level II
MTTF	10 years +

#### AGENCY CERTIFICATIONS

UL 916  
CE EN 61326-1  
FCC Part 15 Subpart B, Class B | FCC Part 15 Subpart C  
C-UL Listed to Canadian Standards Association (CSA)C22.2 No. 205-M1983 "Signal Equipment"  
1999/5/EC R&TTE Directive  
CCC | SRRC | RSS | RoHS

## DIMENSIONS AND WIRING

**Note:** Compatible with (DIN43880) enclosures  
 Suitable for mounting to a panel or to an EN50022 standard 35mm rail

### IT-8000

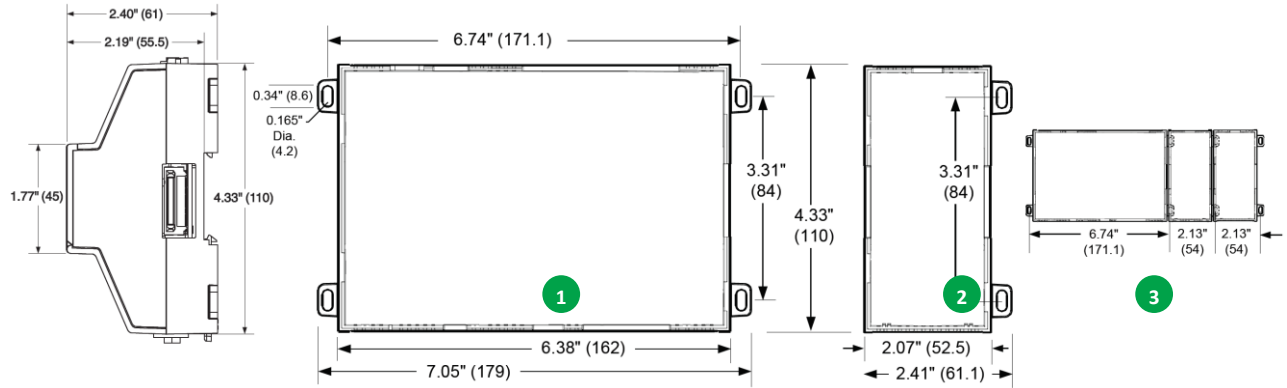

- 1** IT-8000 controller. Allow at least 1.5" (38mm) clearance around all sides and minimum 3" (76mm) at bottom for Wi-Fi antenna
- 2** Expansion module. Up to four (4) may be used. See "Expansion Modules" and "I/O Configuration"
- 3** Distances between center tabs from one unit to another unit

### IT8-EIO-16

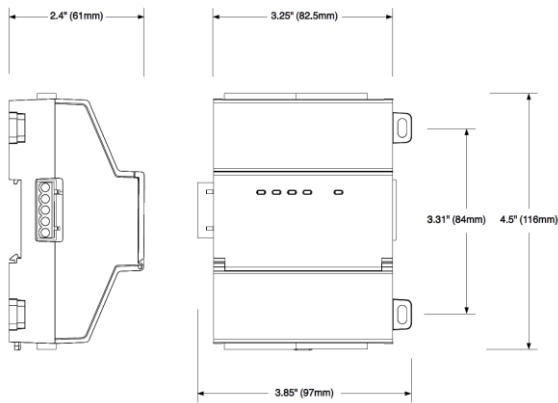

### IT8-EIO-34

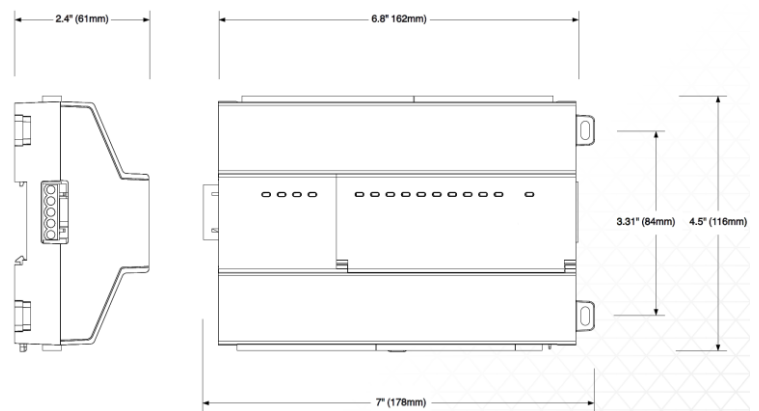

# SYSTEM ARCHITECTURE

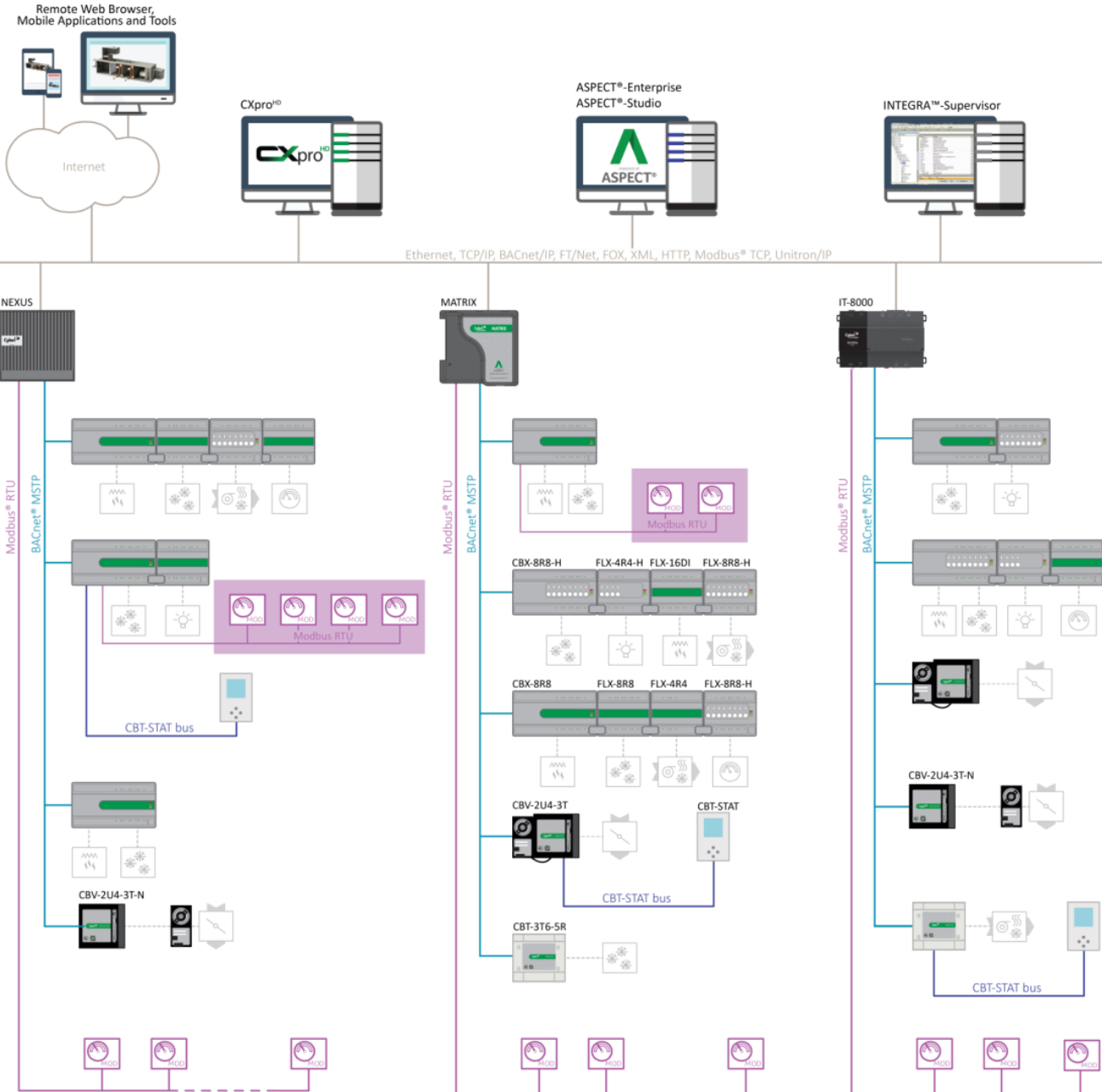

## ORDERING INFORMATION

### IT-8000 US WLAN Wi-Fi BUNDLES

IT-8005-USWIFI	Includes core license for 5 devices or 250 points. Made up of IT-8000-WIFI + IT8-005-COR + IT8-005-SM0.
IT-8010-USWIFI	Includes core license for 10 devices or 500 points. Made up of IT-8000-WIFI + IT8-010-COR + IT8-010-SM0.
IT-8025-USWIFI	Includes core license for 25 devices or 1250 points. Made up of IT-8000-WIFI + IT8-025-COR + IT8-025-SM0.
IT-8100-USWIFI	Includes core license for 100 devices or 5000 points. Made up of IT-8000-WIFI + IT8-100-COR + IT8-100-SM0.
IT-8200-USWIFI	Includes core license for 200 devices or 10000 points. Made up of IT-8000-WIFI + IT8-200-COR + IT8-200-SM0.

### IT-8000 WW (Worldwide) WLAN Wi-Fi BUNDLES

IT-8005-WWWIFI	Includes core license for 5 devices or 250 points. Made up of IT-8000-WIFI + IT8-005-COR + IT8-005-SM0.
IT-8010-WWWIFI	Includes core license for 10 devices or 500 points. Made up of IT-8000-WIFI + IT8-010-COR + IT8-010-SM0.
IT-8025-WWWIFI	Includes core license for 25 devices or 1250 points. Made up of IT-8000-WIFI + IT8-025-COR + IT8-025-SM0.
IT-8100-WWWIFI	Includes core license for 100 devices or 5000 points. Made up of IT-8000-WIFI + IT8-100-COR + IT8-100-SM0.
IT-8200-WWWIFI	Includes core license for 200 devices or 10000 points. Made up of IT-8000-WIFI + IT8-200-COR + IT8-200-SM0.

### IT-8000 UNBUNDLED

IT-8000-USWIFI	2 isolated RS-485 ports, configurable for 9.6 to 115.2 kbps. Support for 2 RS-485 protocols (BACnet MS/TP, LON, Modbus RTU). Two RJ-45 10/100 MB Ethernet with TCP/IP support for FOX, BACnet/IP, and Modbus TCP. Wi-Fi connectivity 802.11 a/b/g/n (US WLAN Country Code). Web Interface, embedded Workbench, integrated power supply and USB backup and restore.
IT-8000-WWWIFI	2 isolated RS-485 ports, configurable for 9.6 to 115.2 kbps. Support for 2 RS-485 protocols (BACnet MS/TP, LON, Modbus RTU). Two RJ-45 10/100 MB Ethernet with TCP/IP support for FOX, BACnet/IP, and Modbus TCP. Wi-Fi connectivity 802.11 a/b/g/n (Worldwide WLAN Code). Web Interface, embedded Workbench, integrated power supply and USB backup and restore.
IT-8000-NOWIFI	2 isolated RS-485 ports, configurable for 9.6 to 115.2 kbps. Support for 2 RS-485 protocols (BACnet MS/TP, LON, Modbus RTU). Two RJ-45 10/100 MB Ethernet with TCP/IP support for FOX, BACnet/IP, and Modbus TCP. NO Wi-Fi CONNECTIVITY. Web Interface, embedded Workbench, integrated power supply and USB backup and restore. Allow a minimum of two weeks for shipment.

### IT-8000 EXPANSION I/O

IT8-EIO-16	IT-8000 16 Point Expansion IO Module. Powered by IT8-RIO-34 or external 15VDC power supply. Features 8UI, 4DO and 4AO. Requires IT-8000 and Niagara4 version 4.3 or higher.
IT8-EIO-34	IT-8000 34 Point Expansion IO Module. Powered by an external 24VAC/DC power supply. Features 16UI, 10DO and 8AO. Requires IT-8000 and Niagara4 version 4.3 or higher.

### IT-8000 ACCESSORIES

IT8-NPB-2X-485	IT-8000 add-on dual port RS-485 module
IT8-NPB-232	IT-8000 add-on single port RS-232 module
IT8-NPB-LON	IT-8000 add-on single port LON FTT10A module
IT8-WPM	IT-8000 wall plug module. 100-240 VAC, 50/60 Hz. Connect to the 2.5 mm barrel plug, 24 V input to the IT-8000 and includes, US, EU, UK and AU plugs
IT8-WIFI-EXT	IT-8000 extension cable and bracket for WLAN antenna

### IT-8000 CORE SOFTWARE LICENSE FILE

IT8-005-COR	Adds support for up to 5 devices or 250 points. Requires IT-8000 & IT8-005-SM0
IT8-010-COR	Adds support for up to 10 devices or 500 points. Requires IT-8000 & IT8-010-SM0
IT8-025-COR	Adds support for up to 25 devices or 1,250 points. Requires IT-8000 & IT8-025-SM0
IT8-100-COR	Adds support for up to 100 devices or 5,000 points. Requires IT-8000 & IT8-100-SM0
IT8-200-COR	Adds support for up to 200 devices or 10,000 points. Requires IT-8000 & IT8-200-SM0

### IT-8000 INITIAL DEVICE CAPACITY PACK

IT8-010-DCP	Adds support for an additional 10 devices or 500 points to the core (IT8-XXX-COR). Purchased at time of initial order with core software.
IT8-025-DCP	Adds support for an additional 25 devices or 1,250 points to the core (IT8-XXX-COR). Purchased at time of initial order with core software.
IT8-050-DCP	Adds support for an additional 50 devices or 2,500 points to the core (IT8-XXX-COR). Purchased at time of initial order with core software.

IT-8000 FIELD UPGRADE FOR DEVICE CAPACITY PACK

IT8-010-DCU	Adds support for an additional 10 devices or 500 points to the core (IT8-XXX-COR). Purchased any time after initial core software purchase.
IT8-025-DCU	Adds support for an additional 25 devices or 1,250 points to the core (IT8-XXX-COR). Purchased any time after initial core software purchase.
IT8-050-DCU	Adds support for an additional 50 devices or 2,500 points to the core (IT8-XXX-COR). Purchased any time after initial core software purchase.

IT-8000 SERVICE AND MAINTENANCE AGREEMENTS

IT8-005-SM0	18-month software maintenance agreement.
IT8-005-SM1	1-year software maintenance agreement for core software IT8-005-COR.
IT8-005-SM3	3-year software maintenance agreement for core software IT8-005-COR.
IT8-005-SM5	5-year software maintenance agreement for core software IT8-005-COR.
IT8-010-SM0	18-month software maintenance agreement. Must be purchased in conjunction with initial core software IT8-010-COR. Optional 3 or 5-year maintenance may be substituted.
IT8-010-SM1	1-year software maintenance agreement for core software IT8-010-COR.
IT8-010-SM3	3-year software maintenance agreement for core software IT8-010-COR.
IT8-010-SM5	5-year software maintenance agreement for core software IT8-010-COR.
IT8-025-SM0	18-month software maintenance agreement. Must be purchased in conjunction with initial core software IT8-025-COR. Optional 3 or 5-year maintenance may be substituted.
IT8-025-SM1	1-year software maintenance agreement for core software IT8-025-COR.
IT8-025-SM3	3-year software maintenance agreement for core software IT8-025-COR.
IT8-025-SM5	5-year software maintenance agreement for core software IT8-025-COR.
IT8-100-SM0	18-month software maintenance agreement. Must be purchased in conjunction with initial core software IT8-100-COR. Optional 3 or 5-year maintenance may be substituted.
IT8-100-SM1	1-year software maintenance agreement for core software IT8-100-COR.
IT8-100-SM3	3-year software maintenance agreement for core software IT8-100-COR.
IT8-100-SM5	5-year software maintenance agreement for core software IT8-100-COR.
IT8-200-SM0	18-month software maintenance agreement. Must be purchased in conjunction with initial core software IT8-200-COR. Optional 3 or 5-year maintenance may be substituted.
IT8-200-SM1	1-year software maintenance agreement for core software IT8-200-COR.
IT8-200-SM3	3-year software maintenance agreement for core software IT8-200-COR.
IT8-200-SM5	5-year software maintenance agreement for core software IT8-200-COR.

IT-8000 MISCELLANEOUS

IT8-FIPS	Provides FIPS 140-2 Level 1 conformance using the integrated FIPS certified BouncyCastle module for IT-8000. Requires IT-8000 version 4.6 and later.
IT8-OS-AX	Enables IT-8000 to run Niagara <sup>AX</sup> operating system instead of N4.

IT-8000 DRIVERS

IT8-DR-AC	Andover Controls AC256 over RS-232 or RS-485. (Beta version only)
IT8-DR-AINF	Andover Controls Infinity.
IT8-DR-APHP	American Auto-Matrix PHP over RS-232 or RS-485. Manufactured by 3rd party. Limited support.
IT8-DR-APUP	American Auto-Matrix PUP over RS-232 or RS-485. Manufactured by 3rd party. Limited support.
IT8-DR-CCN	Carrier Comfort Network.
IT8-DR-FLEX	Flex over RS-232 or RS-485.
IT8-DR-GLOB	IR controlled AV equipment via an RS-232 connection to a Global Cache FC module. Requires IT8-OS-AX. Supported in AX version 3.8U1 only.
IT8-DR-HELV	Helvar Lighting Control. Requires IT8-OS-AX. Supported in AX version 3.8U1 only.
IT8-DR-HORT	European Hortsmann meters. Requires IT8-OS-AX. Supported in AX version 3.8U1 only.
IT8-DR-JOS	Josam Grease Trap Sensor. Requires IT8-OS-AX. Supported in AX version 3.8U1 only.
IT8-DR-LANGOVN	Lang Oven over RS-232 or RS-485. Requires IT8-OS-AX. Supported in AX version 3.8U1 only.
IT8-DR-MCQUAY	McQuay to OPM driver.
IT8-DR-MFID	Micros Fidelio IP driver.
IT8-DR-VDRT	Veeder-Root over RS-232 or RS-485. Requires IT8-OS-AX. Supported in AX version 3.8U1 only.

Cylon and UniPuts are registered trademarks of Cylon Controls. Auto-Matrix, ASPECT, ASPECT-Enterprise, ASPECT-Studio, Auto-Flow, INTEGRA, Smart building solutions, flexible building solutions, Solution Integrator and V-STAT are either trademarks of registered trademarks of American Auto-Matrix, trading as Cylon Auto-Matrix, a division of Cylon Controls Ltd. BACnet is a registered trademark of ASHRAE; BTL is a registered trademark of the BACnet Manufacturers Association; Niagara<sup>AX</sup> Framework is a registered trademark of Tridium, Inc.; All other trademarks are property of their respective owners.